

A comparison of the performance of two and three-dimensional thermal bridge assessment for typical construction joints

Ulrich Pont – TU Wien | Dep. of Building Physics and Building Ecology – ulrich.pont@tuwien.ac.at

Ardeshir Mahdavi – TU Wien | Dep. of Building Physics and Building Ecology – amahdavi@tuwien.ac.at

Abstract

The consideration of thermal bridges in building envelopes gained importance in recent years. This is due to their potential impact on the overall thermal building performance of highly-insulated buildings. Moreover, energy-efficient buildings tend to be more sensitive to problems associated with thermal bridges, such as surface condensation, mould growth, and thermal comfort issues. Therefore, planners must minimize the negative impact of thermal bridges. Although user-friendly thermal bridge simulation tools are available, they are not yet widely used in practice. Instead, planners often rely on generic details from the building construction literature. The thermal performance of such details often remains unknown, given the wide range of possible building materials (and their thermal properties). In this contribution, we present the results of a thermal bridge simulation of a set of such standard details. Thereby, we assessed vertical sections through typical constructions via 2D thermal bridge simulation, as well as 3D corner situations constituted by such 2D sections. This was done to address two research questions: i. How do typical details perform, given the large range of thermal properties of applied materials? ii. How does the performance of the 3D-thermal bridges compare to their constituent 2D-details, and is it possible to use 2D results to approximate the results of 3D thermal bridges?

1. Introduction

The quality of building envelope has a significant impact on buildings' energy use, indoor conditions and hygiene, and overall durability. Overall building assessment routines regularly utilize a simplified, one-dimensional approach for the assessment of heat and mass flow through building envelope components such as EN ISO 6946 (ISO

2007). In recent years, as a consequence of more stringent building regulations, the relative importance of thermal bridges within highly insulated envelopes has increased. The behaviour of thermal bridges regarding heat and mass flow cannot be captured via simplified (1D) models. Thermal bridges can increase heat losses and reduce indoor surface temperatures. They can cause surface condensation, mould growth, water-induced degradation of building components. In the past decades, detailed numeric evaluation methods (Heindl et al. 1987, Heindl et al. n.d., Mahdavi et al. 1992) and powerful computational assessment tools have been developed (Kornicki et al. 2012, Pont et al. 2016, Antherm 2016). However, even with such tools, planners face a number of challenges, such as the lack of input data, handling problems with the model and simulation setup conventions (Ward and Sanders 2007), and – more generally – lack of time, knowledge, and financial resources. In this context, we address two research questions: i. How well do typical details perform, given the large range of thermal properties of applied materials? ii. How does the performance of the 3D thermal bridges compare to their constituent 2D details? Is it possible to use 2D results to approximate the behaviour of 3D thermal bridges? To address these questions, we obtained a number of 2D construction details (vertical sections through building assemblies) from pertinent literature and assessed those using a numeric simulation tool. Thereby, we varied the input data (thermal conductivity) based on material property catalogues to answer the first question. Subsequently, we converted the 2D details to 3D details, repeated the simulation, and compared the 2D and 3D results.

2. Methodology

2.1 Material properties, boundary conditions & scenarios

Basic assessment of thermal bridges (steady state boundary conditions, focus on heat flow and temperature distributions) requires at least the thermal conductivity (λ) of the materials and conditions of the adjacent spaces (surface resistance values, room temperatures). In the building planning process, performance specialists are required to make assumptions regarding the physical properties of the used materials. Normative documents, such as the ÖNORM B 8110-7 (ASI 2013), include design values, which are intended for use in different performance-related inquiries, when detailed values are not available. However, the standard offers a multitude of generic materials and does not include a guideline as to which values should be used in which type of assessment. Thus, this decision needs to be made by the planners, and leaves a wide range of values open.



















Table 2 provides an overview of standard-based minimum, maximum, and average λ values for different types of materials (such as insulation, concrete, bricks, etc.).

Regarding boundary conditions, we assume temperatures of $-10\text{ }^{\circ}\text{C}$ (outdoor), $20\text{ }^{\circ}\text{C}$ (conditioned indoor spaces), and $5\text{ }^{\circ}\text{C}$ (unheated indoor spaces). Surface heat transfer resistance values are set to $0.04\text{ m}^2\cdot\text{K}\cdot\text{W}^{-1}$ (outdoor) and $0.25\text{ m}^2\cdot\text{K}\cdot\text{W}^{-1}$ (indoor) (DIN 2012). A number of simulation scenarios were defined as per Table 1. The construction joints are assessed as 2D thermal bridges. To generate 3D details we follow two approaches: For a number of details, we generate corner details based on the 2D sections (Details A to D, see section 2.2 below). Thereby the sections are revolved by 90 degrees (Fig. 1). The other approach is a “layered” approach; Thereby, successive 2D sections with respective dimensions on the z-coordinate are layered together resulting in the 3D representation of the construction (Fig. 2). All scenarios are applied to both 2D and 3D details.

Table 1 – Simulation scenarios

Scenario	Description
S1	All conductivities set to minimum
S2	All conductivities set to maximum
S3	All conductivities set to average
S4	As S3, but insulation materials set to min.
S5	As S2, but insulation materials set to min.

Table 2 – Conductivity values, as stated in ÖNORM B 8110-7 for different building materials.

ID / Hatch	Name	Min. λ [W.m ⁻¹ .K ⁻¹]	Max. λ [W.m ⁻¹ .K ⁻¹]	Average λ [W.m ⁻¹ .K ⁻¹]
1 	Flexible insulation	0.031	0.066	0.049
2 	Rigid insulation	0.031	0.066	0.049
3 	Concrete (reinforced)	2.300	2.500	2.400
4 	Masonry (<30 cm)	0.230	0.577	0.404
5 	Masonry (≥30 cm)	0.089	0.130	0.110
6 	Insulated wall element	0,230	0,577	0,404
7 	Plaster (inside)	0.180	0.570	0.375
8 	Plaster (outside)	0.120	1.050	0.585
9 	Screed	0.470	1.580	1.025
10 	Foil	0.130	0.400	0.265
11 	Water proofing	0.130	0.400	0.265
12 	Perimeter protection	0.100	0.500	0.300
13 	Soil / gravel	1.500	2.000	1.750
14 	Natural stone element	0.120	6.000	3.060
15 	Glass	1.000	1.000	1.000
16 	(Stainless) Steel	30.000	50.000	40.000
17 	Timber	0.110	0.240	0.175
18 	Vacuum	0.00001	0.00001	0.00001

A comparison of the performance of two and three-dimensional thermal bridge assessment for typical construction joints

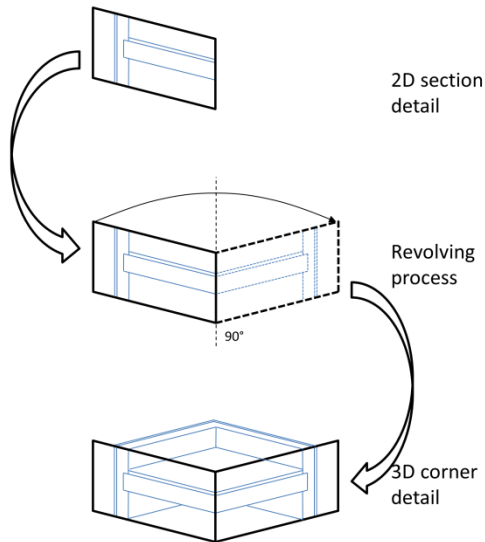

Fig. 1 – Conversion from 2D model to (revolved) 3D corner detail model

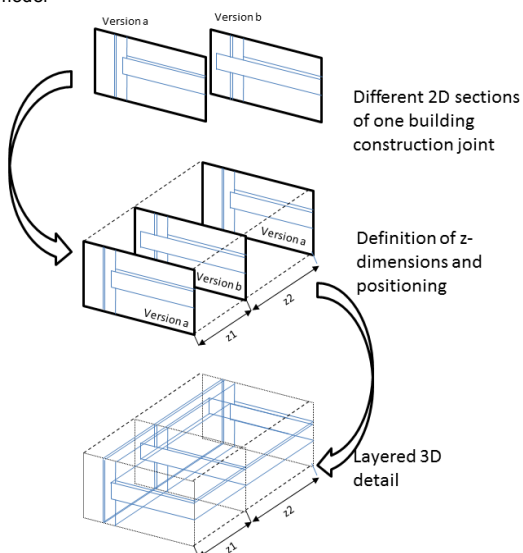

Fig. 2 – Conversion from 2D model to layered 3D detail model

2.2 Assessed building construction joints

Five construction joints were selected for this study, based on Beinhauer 2003, Antherm 2016, Baubook 2016, and previous research work related to vacuum glass (Proskurnina et al. 2016). These details are:

- A: Connection of a slab and an external wall over a soil-adjacent basement (Fig. 3).
- B: Connection of a slab in an external wall between two conditioned floors (Fig. 4).
- C: Connection of a flat roof and an external wall (surrounding an Attica) (Fig. 5).
- D: Lower corner of a bay construction (Fig. 6).
- E: Vacuum glass, between two adiabatic

boundary planes (E1 without pillars, E2 with pillars; Fig 7.)

The hatch patterns in the Figures indicate the material assumed for the specific components in Details A to D (see Table 2).

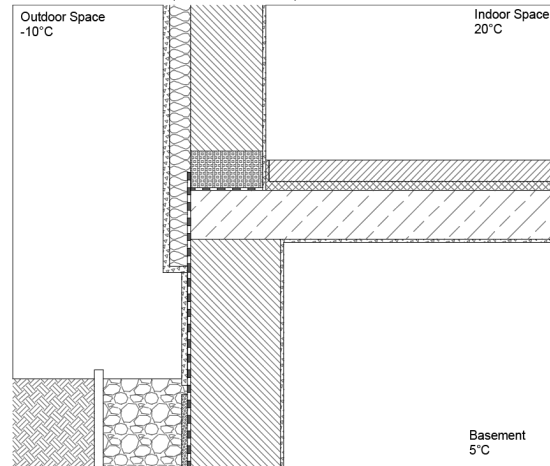

Fig. 3 - Detail A., Section 1:25

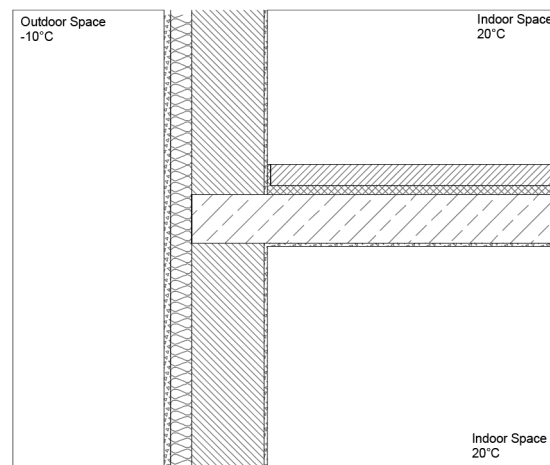

Fig. 4 - Detail B., Section 1:25

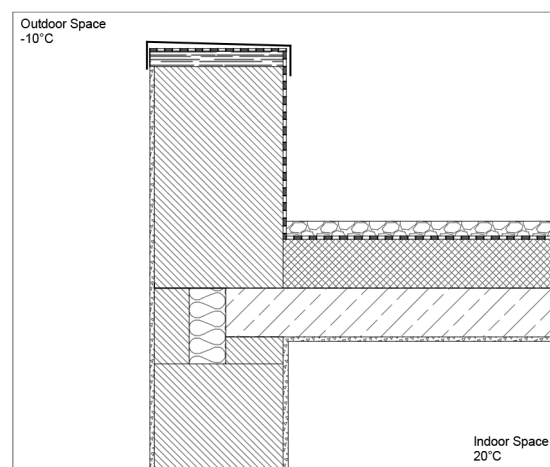

Fig. 5 - Detail C., Section 1:25

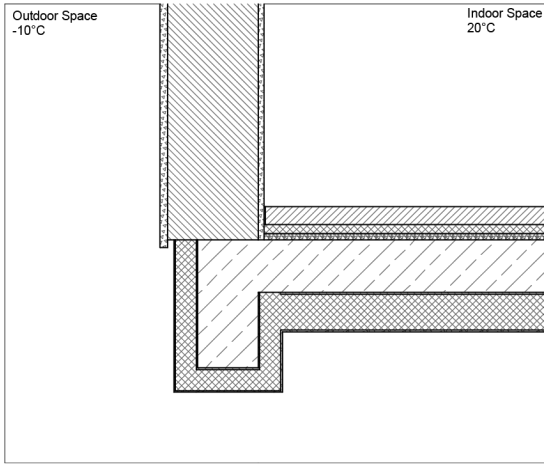

Fig. 6 - Detail D., Section 1:25

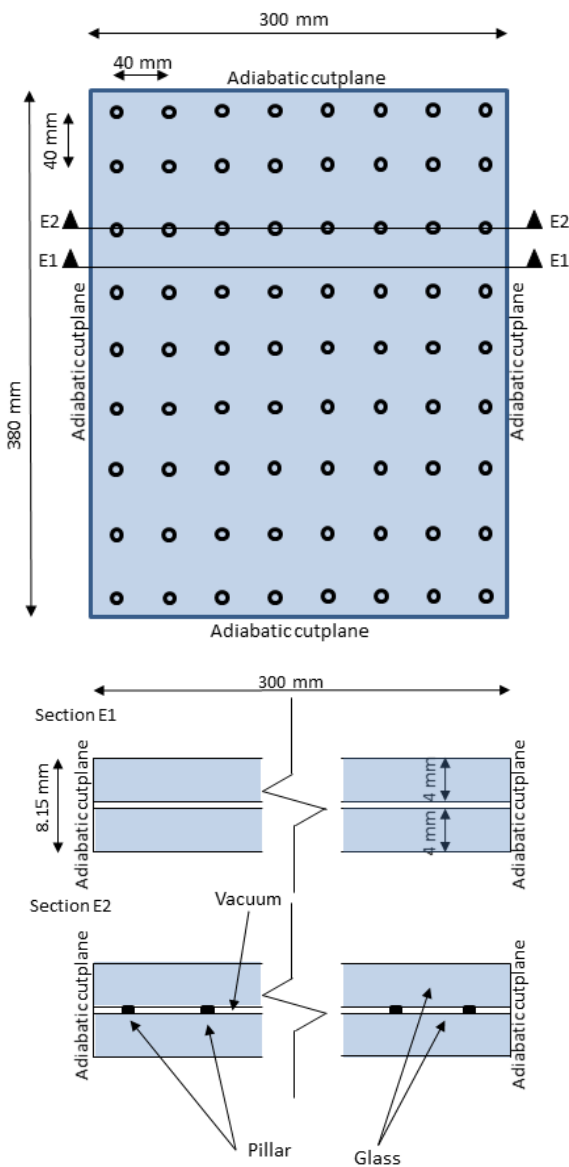

Fig. 7 – Scheme and sections (Detail E1 and E2)

Note that simulation models are distinguished via abbreviations. For instance, A_2D_S1 denotes the 2D simulation model for detail A and scenario S1.

2.3 Simulation settings and indicators

The applied numeric simulation tool used was Antherm 8 (Antherm 2016). Details' geometry was drafted in a CAD tool (Draftsight 2016) and exported to Antherm. The level of detail for the calculation in Antherm was set to 2 mm minimum cell size for Details A-D, and to 0.02 mm minimum cell size for Detail E.

The following indicators were selected for assessment purposes:

- **Temperature** and **saturation relative humidity** of the coldest point of the internal surface
- **Temperature factor** f_{Rsi} (Equation 1), that is the temperature difference between the lowest indoor surface temperature (θ_{si}) and outdoor temperature (θ_e) divided by the indoor (θ_i) outdoor temperature difference.

$$f_{Rsi} = \frac{\theta_{si} - \theta_e}{\theta_i - \theta_e} [-] \quad (1)$$

Standards (DIN 2014) state values for f_{Rsi} equal or lower to 0.57 (surface condensation), 0.70 (mould growth) and 0.88 (corrosion of metallic surfaces) as critical.

- **Heat Flow** Q denotes heat transfer from an indoor (warmer) space to outdoor environment.
- **Thermal coupling coefficient** L^{2D} / L^{3D} (Equation 2 and 3). This is the quotient of the total heat flow Q from the internal to the external environment of a detail and the temperature difference between inside and outside.

$$L^{2D} = \frac{Q}{\theta_i - \theta_e} [W \cdot m^{-1} \cdot K^{-1}] \text{ (2D-models)} \quad (2)$$

$$L^{3D} = \frac{Q}{\theta_i - \theta_e} [W \cdot K^{-1}] \text{ (3D-models)} \quad (3)$$

3. Results and Discussion

3.1 Impact of different conductivity assumptions

Fig. 8 (end of contribution) illustrates the minimum

A comparison of the performance of two and three-dimensional thermal bridge assessment for typical construction joints

and maximum surface temperatures for all scenarios, together with the f_{Rsi} values. In general, a significant impact due to different material assumptions can be seen for details A-D, but not for detail E, whose composition did not involve variation in conductivity assumptions. For Detail A-D, S1 shows the best results (high surface temperatures, high f_{Rsi} value, and low heat flow), whereas S2 shows the poorest results. In case of 2D simulation, the S2 temperature results are between 1.77 (detail B) and 4.43 K (detail D) lower than S1 results. In 3D simulations for details A-D, the temperature difference ranges from 2.28 (detail C) to 3.88 K.

Regarding the f_{Rsi} values, S2 scenarios show in 2D evaluation values that are between 7 (detail C) and 25% (detail D) lower than S1 scenarios. This deviation amounts to relative differences between 10 (detail C) and 31% (detail D) in 3D evaluation. Note that some of the details fulfill certain standard-based requirements (such as the limit for surface condensation), if executed with highly-insulating materials, but fail otherwise. For instance, detail A features an f_{Rsi} value higher than 0.71 (mold growth criteria) in 3D simulation in scenario S1, but fails in scenario S2 (f_{Rsi} of 0.61).

Fig. 9 shows surface temperature distributions in A_3D_S1 and A_3D_S2.

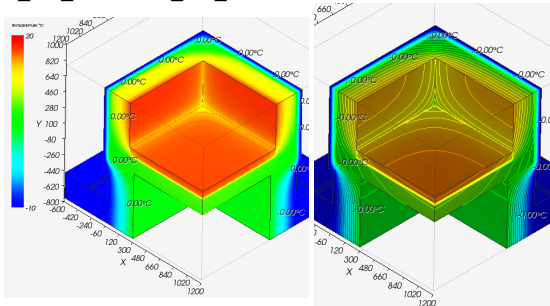

Fig. 9 – Surface temperature distribution: A_3D_S1 (left) and A_3D_S2 (right).

From the viewpoint of thermal transmittance, the heat flow rates in S2 scenarios are 158 – 232% (2D simulation), respectively 150 – 230% (3D simulation) higher than in S1. Results of S3, S4, and S5 fall between S1 and S2

3.2 Comparison between 2D and 3D assessment

Fig. 8 (end of contribution) contrasts the results of

2D and 3D simulations against each other. The results for details A to D show a significant impact of the corner situation, resulting in colder surface temperatures and reduced f_{Rsi} values in the 3D-simulation. The temperature differences 2D and 3D simulation for these details range from 2.74 (detail B, Scenario 5) to 5.58 K (detail D, Scenario 1).

The 2D simulations of E1 (no pillars) and E2 (section with pillars) show significant differences, but do not allow to predict the overall result of the element. The 3D-simulation (see Fig. 10), which considers the small z-dimension of the pillars, shows a result closer to E1. The lowest surface temperature is close to 1 K lower than in E1 simulation, but more than 14 K larger than in E2 simulation.

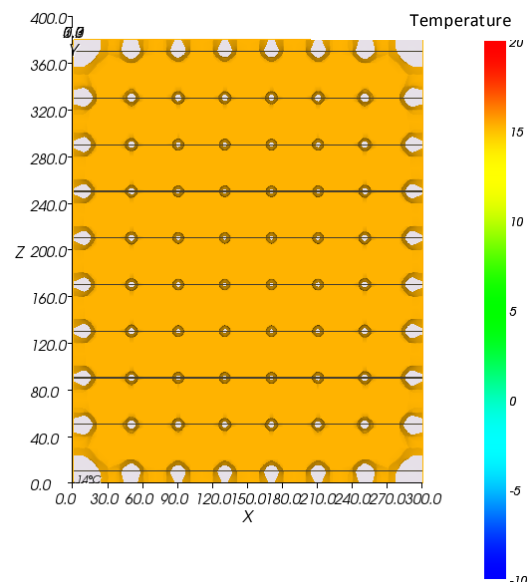

Fig. 10 – Surface temperatures for detail E (3D simulation).

4. Conclusion & Future research

We numerically analysed a number of thermal bridges to answer two research question, namely the impact of the thermal property assumptions on the performance of the details, and the potential of 2D simulation for estimation of 3D details' behaviour.

Regarding material properties assumptions, the results suggest that:

- Material properties can have a significant impact on the simulated thermal performance of the detail.

- Construction details such as A-D, which can be found in the building construction literature, do not necessarily perform well, if the underlying material qualities are not sufficiently high. Numeric thermal bridge simulation can facilitate the definition of minimum material properties requirements for product selection.

Regarding the utility of 2D simulation to infer behaviour of 3D details, the results suggest that:

- 2D simulation of 3D thermal bridges needs to be assessed carefully, given potentially large differences between 2D and 3D results. In critical cases, 3D simulation should be understood as necessary requirement.
- Needless to say, differences between 2D and 3D results depend on the nature of the details. In the present study, 3D thermal bridge simulations yielded, for the same boundary conditions, surface temperatures up to 6 K below those in 2D analysis. Such differences need to be considered, given the increased condensation and mould growth risk due to lower surface temperatures, even at rather low indoor relative humidity.

Future research efforts shall address a broader set of construction instances. Moreover, assumptions regarding the surface resistance values in corner situations (3D thermal bridges) should be further scrutinised.

Acknowledgement

The research presented in this contribution was partly conducted within the framework of the following two research projects: VIG-SYS-RENO (P. 845225) and MOTIVE (P. 854690), both funded by the Austrian Research Promotion Agency (FFG) in the framework of the programme "Stadt der Zukunft".

References

- Antherm 2016. www.antherm.eu (last accessed 23.12.2016)
- ASI 2013. Austrian Standard 8110 – 7: Thermal insulation in building construction — Part 7: Tabulated design values for thermal insulation; Austrian Institute of Standardization, 2013.
- Baobook 2016. www.baobook.info (last accessed

23.12.2016)

- Beinhauer P. *Standard-Detail-Sammlung*. Rudolf Müller GmbH & Co KG. ISBN 978-3481019167
- DIN 2012. DIN EN ISO 13788 *Wärme- und feuchtetechnisches Verhalten von Bauteilen und Bauelementen – Raumseitige Oberflächentemperatur zur Vermeidung kritischer Oberflächenfeuchte und Tauwasserbildung im Bauteilinneren – Berechnungsverfahren (ISO 13788:2012)*; Deutsches Institut für Normung e.v.
- DIN 2014. *DIN 4108-3 Thermal protection and energy economy in buildings – Part 3: Protection against moisture subject to climate conditions – Requirements and directions for design and construction* Deutsches Institut für Normung e.v.
- Draftsight 2016. <http://www.3ds.com/> (last accessed 23.12.2016)
- Heindl, W., Krec, K., Panzhauser, E., Sigmund, A. 1987. *Wärmebrücken – Grundlagen, einfache Formeln, Wärmeverluste, Kondensation – 100 durchgerechnete Baudetails*. Springer – Wien-New York, ISB: 3-211-82024-8
- Heindl W., Panzhauser, E., Krec, K., Sigmund A., Kornicki, T. n.d. *WAEBRU – 2D and 3D Wärmebrücken-Berechnungsprogramm*
- ISO 2007. *EN ISO 6946 – Building Components and building elements – Thermal resistance and thermal transmittance – Calculation method*. 2007, International Standardization Organization.
- Kornicki, T., Nackler, J., Krec, K. 2012. 4D Simulation – Implementation of a periodic thermal conduction model in a 4D simulation program. *Czasopismo Techniczne – Technical Transaction, Politechniki Krakowskiej*. 2-B/2012, Issue 3, 109.
- Mahdavi, A., Jeung, T.-Y., Mathew, P. 1992. „Conductive Heat Transfer through Insulated Building Enclosure Components; A Cross-Section Analysis of Constructions Typical to Low-Rise Residential and Commercial Buildings in North America“. In *Journal of Thermal Insulation and Building Envelopes* Vol. 16/Oct 1992; ISSN 1065-2744, Technomic Publishing, Lancaster, USA
- Pont, U., Proskurnina, O., Kornicki, M., Volko, C., Kornicki, T. 2016. "Recent Developments in

A comparison of the performance of two and three-dimensional thermal bridge assessment for typical construction joints

Application of Simplifications for Numeric Thermal Bridging Evaluation: A work Report"; in: "(Printed) Proceedings of CESB 2016: Central Europe towards sustainable building 2016 - innovations for sustainable future", P. Hájek, J. Tywoniak, A. Lupisek (Ed.); Prague, Czech Republic (2016), ISBN: 9788027102488 Paper-Nr. 1439 (p. 269-276), 8 S.

Proskurnina, O., Pont, U., Mahdavi, A. 2016 "The Performance of Vacuum Glazing in existing

window constructions: A case study" in *Proceedings of the Central European Symposium on Building Physics, September 14-16, Dresden, Germany*, Fraunhofer IRB Verlag, J. Grunewald (ed.); Paper D-04-2, p435- 440

Ward, T., Sanders, C. 2007. *Conventions for Calculating Linear Thermal Transmittance and Temperature Factors*. BRE press, Watford, UK, ISBN: 978-1-86081-986-5

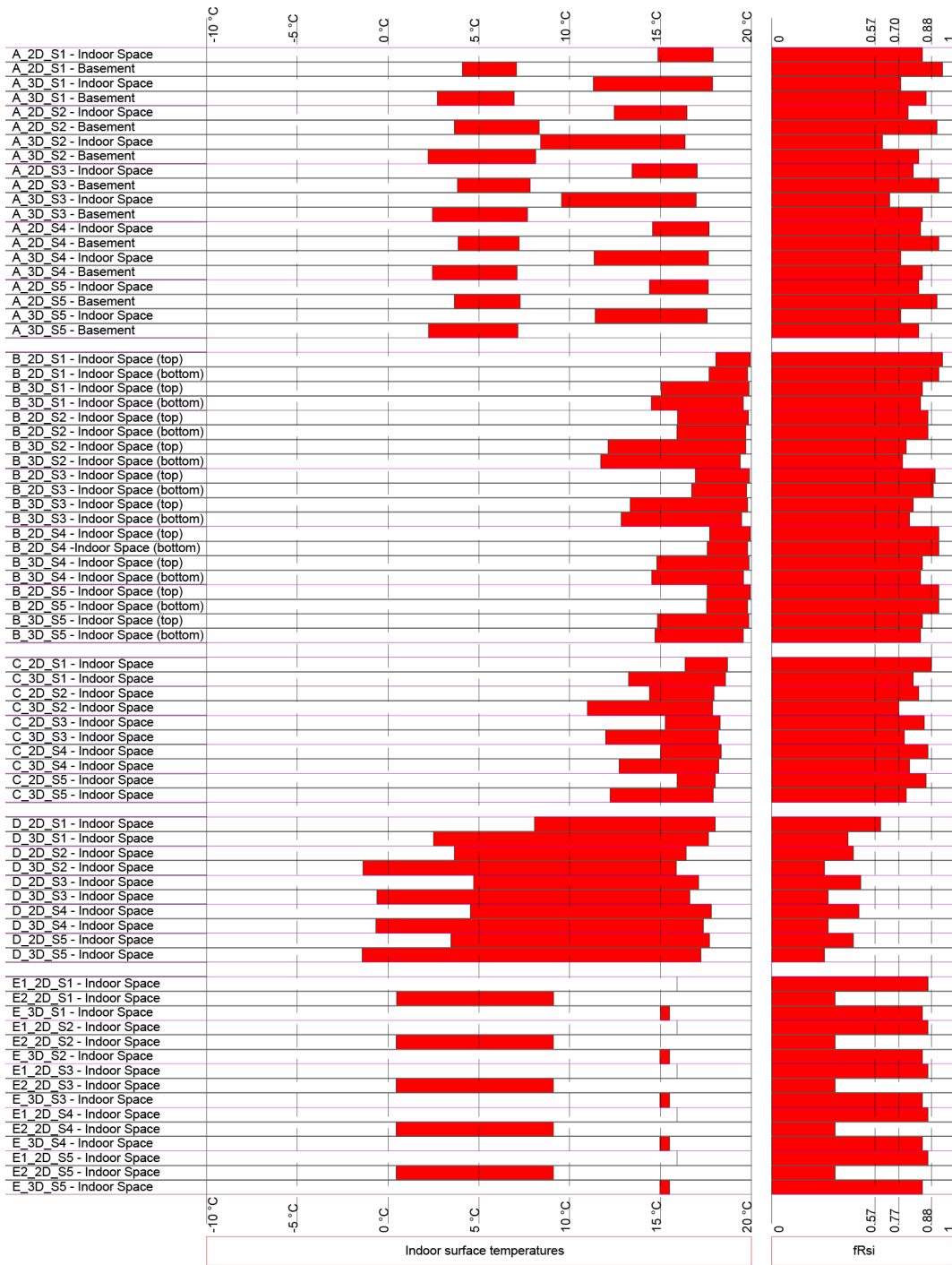

Fig 8 – Results overview (surface temperatures and f_{Rsi} values). Calculations are coded as {Detail_2D/3D-Simulation_Scenario}.